

# SAT Service Manual

## Bedieneinheit BE-Plus für STC 1200 STC 332

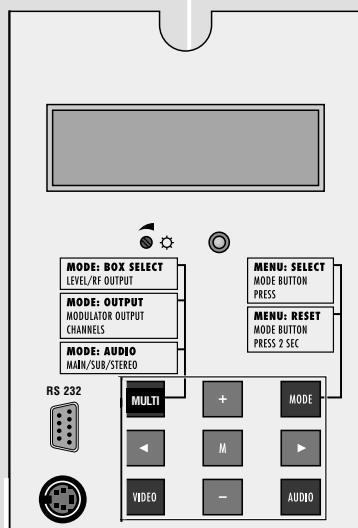

Zusätzlich erforderliche Unterlagen für den Komplettservice  
Additionally required Service Documents for the Complete Service

### Service Manual

### Sicherheit Safety

Materialnr./Part No.  
72010 800 0000

## Grundig Service

Hotline Deutschland...  
...Mo.-Fr. 8.00-18.00 Uhr

### Technik:

TV	0180/52318-41
TV	0180/52318-49
SAT	0180/52318-48
VCR/LiveCam	0180/52318-42
HiFi/Audio	0180/52318-43
Car Audio	0180/52318-44
Telekommunikation	0180/52318-45
	Fax: 0180/52318-51
Planatron (8.00-22.00 Uhr)	0180/52318-99

### Ersatzteil-Verkauf:

Mo.-Fr. 8.00-19.00 Uhr

Telefon: 0180/52318-40  
Fax: 0180/52318-50

Materialnummer/Part Number 72010 030 6000

Änderungen vorbehalten/Subject to alteration • Printed in Germany

E-BS33 0700

<http://www.grundig.com>

<p>Es gelten die Vorschriften und Sicherheitshinweise gemäß dem Service Manual "Sicherheit", Materialnummer 72010 800 0000, sowie zusätzlich die eventuell abweichenden, landesspezifischen Vorschriften!</p>		<p>The regulations and safety instructions shall be valid as provided by the "Safety" Service Manual, part number 72010 800 0000, as well as the respective national deviations.</p>
---	---	--

Die Bedieneinheit BE-Plus wird in die Kopfstationen STC1200 und STC332 eingebaut und ist rückwärts kompatibel zu der bisher eingebauten Bedieneinheit.  
Der Unterschied bei der Bedieneinheit ist die Flash-Programmierung.

The control unit BE-Plus is fitted into the head stations STC 1200 and STC 332 and is downward compatible to the control units incorporated till today.  
The difference between the control units is the Flash programming.

- Grundlage für den Service sind:
- Service Manual STC1200 (Materialnummer 72010 023 3000)
  - Service Manual STC332 (Materialnummer 72010 023 7000)
  - Service Manual "Sicherheit" (Materialnummer 72010 800 0000)

- Basic instructions for servicing are given in the:
- Service Manual STC1200 (Part number 72010 023 3000)
  - Service Manual STC332 (Part number 72010 023 7000)
  - Service Manual "Safety" (Part number 72010 800 0000)

## Inhaltsverzeichnis

	Seite
<b>Allgemeiner Teil</b> .....	<b>2</b>
Softwarestand abfragen .....	2
Software-Programmierung .....	2
IC86010 (Speicher) .....	2
 <b>Platinenabbildungen</b> .....	 <b>3...6</b>
<b>und Schaltpläne</b>	
Bedieneinheit .....	3
 <b>Ersatzteilliste</b> .....	 <b>7</b>

## Table of Contents

	Page
<b>General Section</b> .....	<b>2</b>
Calling up the software version .....	2
Software programming .....	2
IC86010 (memory) .....	2
 <b>Layout of the P.C.B.</b> .....	 <b>3...6</b>
<b>and Circuit Diagrams</b>	
Control Unit .....	3
 <b>Spare Parts List</b> .....	 <b>7</b>

## Allgemeiner Teil

### Softwarestand abfragen

- Für ca. 3sec. zwei beliebige Tasten (z.B. "Mode" und "Multi") gleichzeitig drücken.
- Im Display wird der Softwarestand angezeigt.

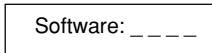

### Software-Programmierung

- Benötigt wird ein Computer mit Win 95 / 98 / 2000 / NT
- Geräte-Software
- Update-Software
- Kabel mit 9-poligem Sub-D-Stecker auf 9-polige Sub-D-Buchse (handelsüblich)

## General Section

### Calling up the software version

- Press any two keys for about 3 seconds (e.g. "Mode" and "Multi") at the same time.
- The software version is shown in the display.

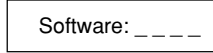

### Software programming

- You need: a computer with Win 95 / 98 / 2000 / NT
- the device software
- the update software
- a cable with 9-pin Sub-D plug to 9-pin Sub-D socket (commercial standard)

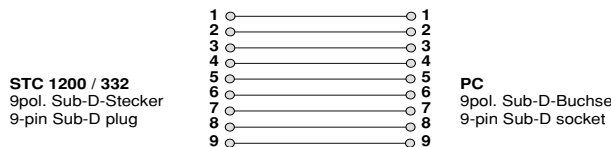

- Die 9-polige Sub-D-Buchse der STC 1200 / 332 über handelsübliches Kabel mit dem 9-poligen Sub-D-Stecker des PC verbinden.
- Stecker des Netzkabels der Kopfstation in Netzsteckdose stecken.
- Update-Software starten.

- Connect the 9-pin Sub-D socket on the STC 1200 / 332 via a commercial cable with the 9-pin Sub-D plug on the PC.
- Connect the mains cable plug of the head station with a wall outlet.
- Run the update software.

Bedienung siehe On-Line-Hilfe.

See the online help for the steps to follow.

Hinweis:

Hint:

Mit der Update Software können unter Punkt "Einstelltdaten lesen" die Daten aus der Kopfstation ausgelesen werden.

It is possible to read out the data via the function "Einstelltdaten lesen" of the update software.

### IC86010 (Speicher)

Im IC86010 werden alle individuellen Einstellungen gespeichert. Beim Tausch der Bedieneinheit kann der gesockelte IC in die neue Bedieneinheit eingesetzt werden. Es sind somit die alten Einstellungen erhalten.

### IC86010 (memory)

All individual settings are stored in the IC86010. When replacing the control unit it is possible to insert the IC into the new control unit. All settings then are maintained.

### Bedieneinheit / Control Unit

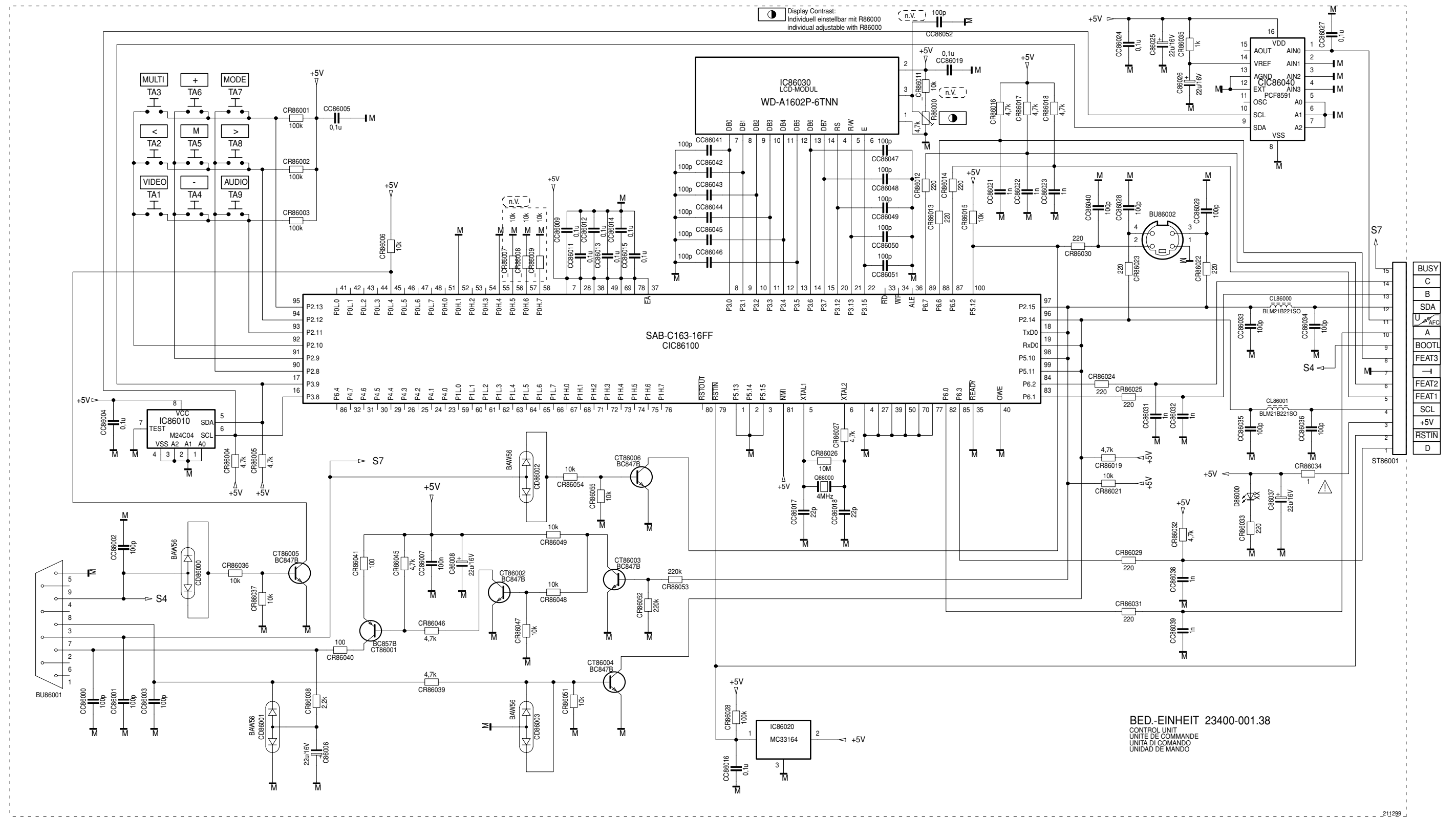

**Bestückungsseite, Ansicht von oben**  
Component side, top view

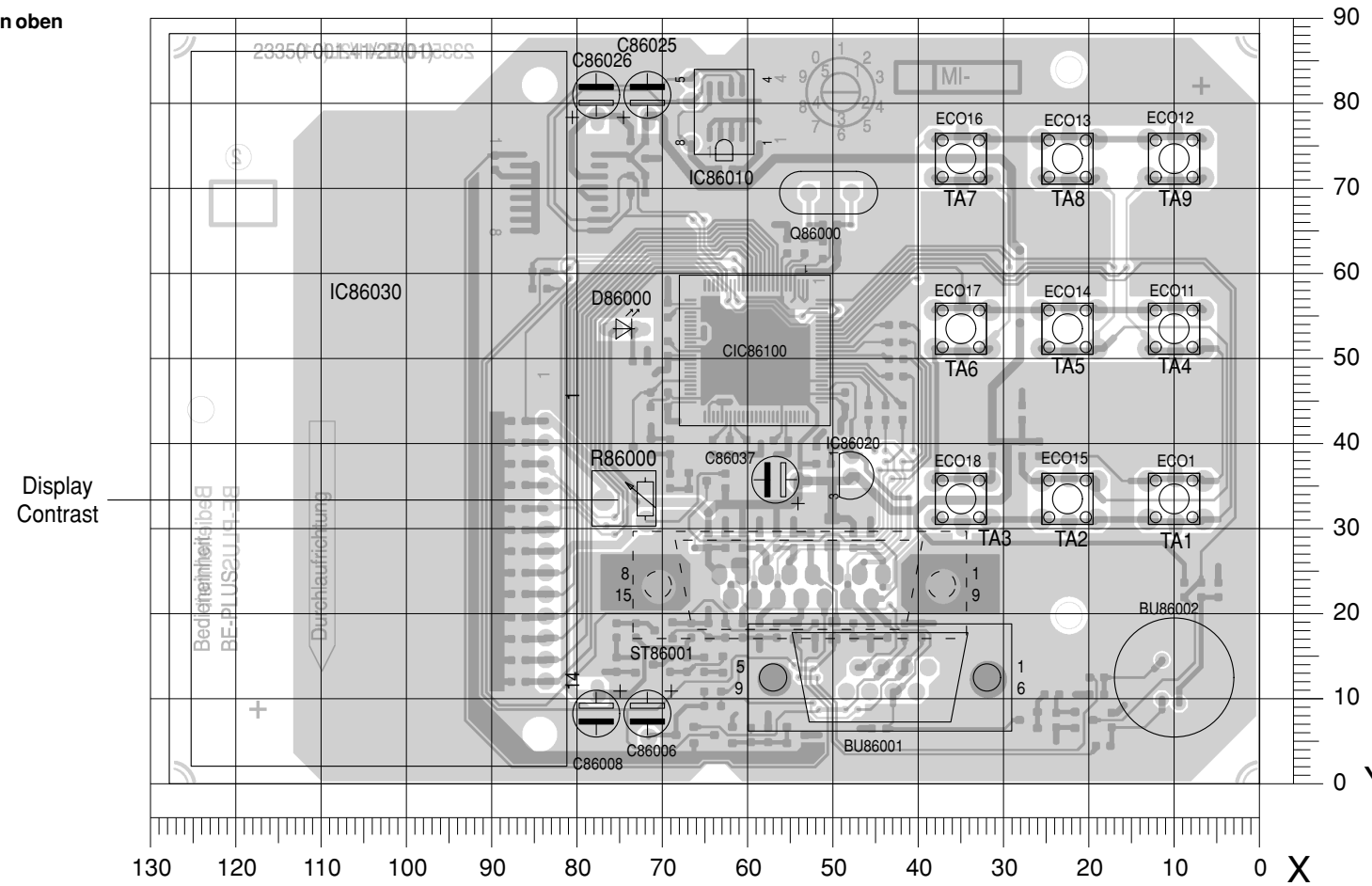

**Koordinaten für die Bauteile der Bestückungsseite (Oberseite)**  
Coordinates of the Components on the Components Side (Top Side)

Pos.-Nr./ Pos. No.	Koordinaten/ Coordinates		Pos.-Nr./ Pos. No.	Koordinaten/ Coordinates	
	X	Y		X	Y
BU86001	44	13	IC86010	63	79
BU86002	10	13	IC86020	47	36
			IC86030	103	44
C86006	71	8	Q86000	51	69
C86008	77	8	R86000	74	34
C86025	72	81			
C86026	78	81	ST86001	54	23
C86037	57	35			
D86000	74	54	TA01 10	33	
ECO01	10	33	TA02 23	33	
ECO11	10	53	TA03 35	33	
ECO12	10	73	TA04 10	53	
ECO13	23	73	TA05 23	53	
ECO14	23	53			
ECO15	23	33	TA06 35	53	
ECO16	35	73	TA07 35	73	
ECO17	35	53	TA08 23	73	
ECO18	35	33	TA09 10	73	

**Bestückungsseite, Ansicht von oben**  
Component side, top view

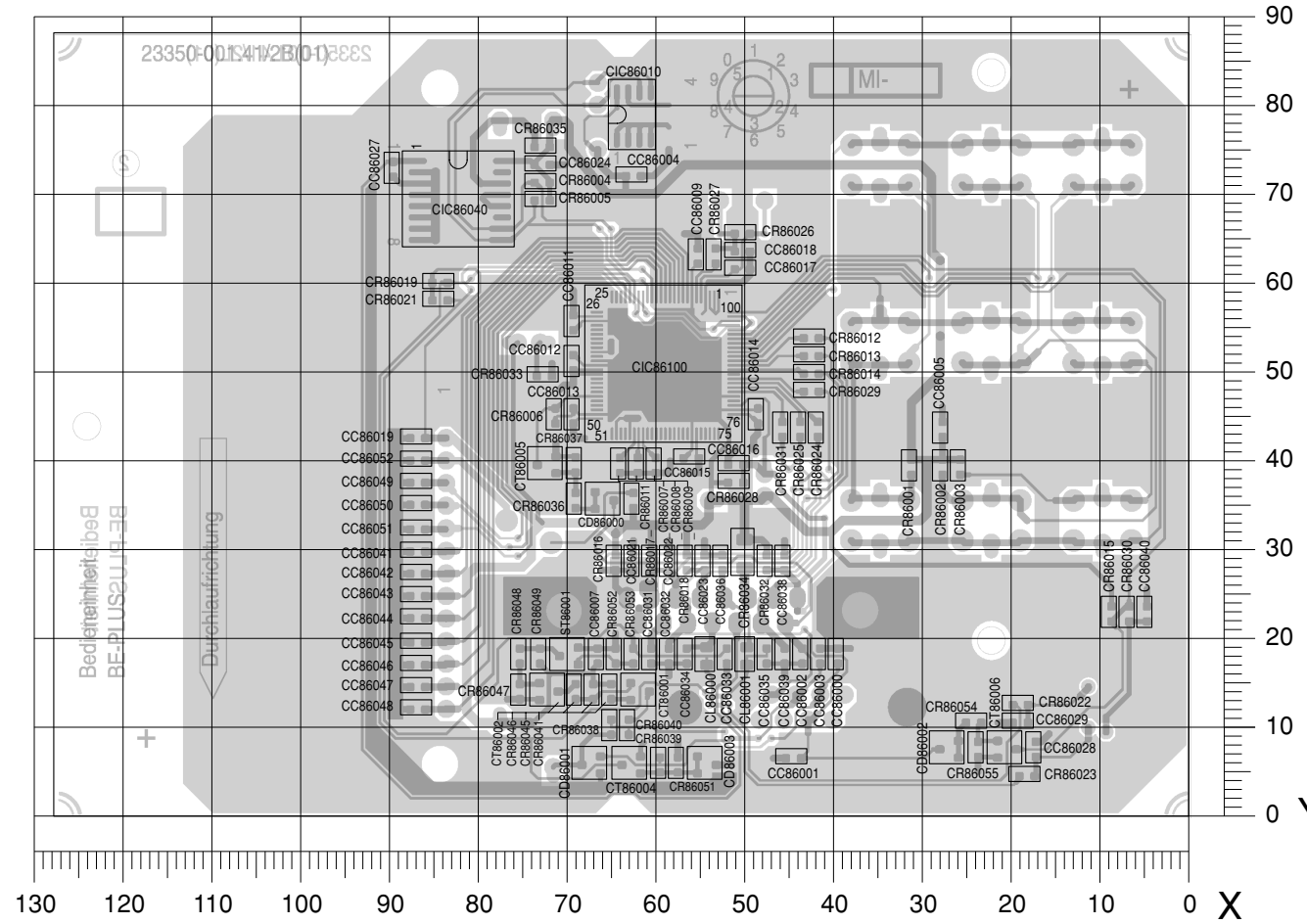

**Koordinaten für die Bauteile der Bestückungsseite (Oberseite)**  
Coordinates of the Components on the Components Side (Top Side)

Pos.-Nr./ Pos. No.	Koordinaten/ Coordinates		Pos.-Nr./ Pos. No.	Koordinaten/ Coordinates		Pos.-Nr./ Pos. No.	Koordinaten/ Coordinates		Pos.-Nr./ Pos. No.	Koordinaten/ Coordinates	
	X	Y		X	Y		X	Y		X	Y
CC86000	40	18	CC86038	46	29	CR86006	72	45	CR86045	67	14
CC86001	45	7	CC86039	46	18	CR86012	43	54	CR86046	69	14
CC86002	44	18	CC86040	5	23	CR86013	43	52	CR86047	76	14
CC86003	42	18	CC86041	87	30	CR86014	43	50	CR86048	76	18
CC86004	63	72	CC86042	87	28	CR86015	9	23	CR86049	73	18
CC86005	28	44	CC86043	87	25	CR86016	65	29	CR86051	58	6
CC86007	67	18	CC86044	87	23	CR86017	61	29	CR86052	65	18
CC86009	56	63	CC86045	87	20	CR86018	57	29	CR86053	63	18
CC86011	69	56	CC86046	87	17	CR86019	84	60	CR86054	25	11
CC86012	69	51	CC86047	87	15	CR86021	84	58	CR86055	24	8
CC86013	69	45	CC86048	87	12	CR86022	19	13	CT86001	62	14
CC86014	49	45	CC86049	87	38	CR86023	19	5	CT86002	72	14
CC86015	56	41	CC86050	87	35	CR86024	42	44	CT86003	70	18
CC86016	51	40	CC86051	87	33	CR86025	44	44	CT86004	63	6
CC86017	51	62	CC86052	87	40	CR86026	51	66	CT86005	73	40
CC86018	51	64	CD86000	66	36	CR86027	53	63	CT86006	21	8
CC86019	87	43	CD86001	68	6	CR86028	51	38			
CC86021	63	29	CD86002	27	8	CR86029	43	48	_CR86007	64	40
CC86022	59	29	CD86003	54	6	CR86030	7	23	_CR86008	62	40
CC86023	55	29				CR86031	46	44	_CR86009	60	40
CC86024	73	73	CIC86010	63	79	CR86032	48	29	_CR86011	63	36
CC86027	90	73	CIC86040	82	69	CR86033	73	50			
CC86028	18	8	CIC86100	59	51	CR86034	50	30			
CC86029	19	11				CR86035	73	76			
CC86031	61	18	CL86000	54	18	CR86036	69	36			
			CL86001	50	18						
CC86032	59	18	CR86001	32	40	CR86037	69	40			
CC86033	52	18	CR86002	28	40	CR86038	65	10			
CC86034	57	18	CR86003	26	40	CR86039	60	6			
CC86035	48	18	CR86004	73	72	CR86040	63	10			
CC86036	53	29	CR86005	73	69	CR86041	65	14			

**GRUNDIG**Ersatzteilliste  
Spare Parts List**SAT****6 / 2000****BEDIENEINHEIT BE-PLUS  
CONTROL UNIT BE**

MATERIAL-NR. / PART NO.: 23400 001 3800

POS. NR. POS. NO.	ABB. FIG.	MATERIAL-NR. PART NUMBER	ANZ. QTY.	BEZEICHNUNG <b>(D)</b>	DESCRIPTION <b>(GB)</b>
		23400 001 3800		BEDIENEINHEIT BE-PLUS	CONTROL UNIT BE-PLUS
0200.000		23100 106 0100		FRONTPLATTE BEDRUCKT	FRONT PANEL PRINTED
0215.000		23100 033 0101		TASTENSATZ 9-FACH	KEY SET 9 FOLD
0216.000		29703 357 0100	9	TASTSCHALTER	KEY SWITCH
0243.000		39615 149 0000		D-SUB BUCHSE 9-POL STEHEND	D-SUB SOCKET STRIP 9 PIN TOP
0244.000		29303 522 0300		S-VHS BUCHSE	S-VHS-SOCKET
0300.000		23800 100 0100		LCD-MODUL WD-A1602P-6TNN	LCD-MODUL WD-A1602P-6TNN

POS. NR. POS. NO.	MATERIAL-NR. PART NUMBER	BEZEICHNUNG DESCRIPTION	POS. NR. POS. NO.	MATERIAL-NR. PART NUMBER	BEZEICHNUNG DESCRIPTION
CD 86000	83093 140 5600	SMD-DIODE BAW 56			
CD 86001	83093 140 5600	SMD-DIODE BAW 56			
CD 86002	83093 140 5600	SMD-DIODE BAW 56			
CD 86003	83093 140 5600	SMD-DIODE BAW 56			
CIC86040	83058 185 9100	SMD IC PCF8591T-T3 SOL16			
CIC86100	83058 281 1600	SMD IC SABC163-16FF			
CL 86000	81049 823 2400	SMD DAEMPF-PERLE 0805 BLM			
CL 86001	81049 823 2400	SMD DAEMPF-PERLE 0805 BLM SMD DAMPING BEAD			
CR86034 	87063 200 0100	SMD R SI 1206 1 OHM 5%			
CT 86001	83010 048 5700	SMD TRANS BC857B			
CT 86002	83010 048 4700	SMD TRANS BC847B			
CT 86003	83010 048 4700	SMD TRANS BC847B			
CT 86004	83010 048 4700	SMD TRANS BC847B			
CT 86005	83010 048 4700	SMD TRANS BC847B			
CT 86006	83010 048 4700	SMD TRANS BC847B			
D 86000	83099 446 0500	LE-DIODE TLHG4601			
IC 86010	72008 670 0400	IC M24C04B1 progr. kpl. IC M24C04B1 progr. cpl.			
IC 86020	83052 100 6400	IC MC33164P-5RP			
Q 86000	83821 620 4100	QUARZ 4 MHZ LNG8-638			
R 86000	87920 021 4600	ESTR.S6 4,7 KOHM LIN			

Es gelten die Vorschriften und Sicherheitshinweise gemäß dem Service Manual "Sicherheit", Mat.-Nummer 72010 800 0000, sowie zusätzlich die eventuell abweichenden, landesspezifischen Vorschriften!



The regulations and safety instructions shall be valid as provided by the "Safety" Service Manual, part number 72010 800 0000, as well as the respective national deviations.

ÄNDERUNGEN VORBEHALTEN / SUBJECT TO ALTERATION

# GRUNDIG

## Kundendienst Deutschland

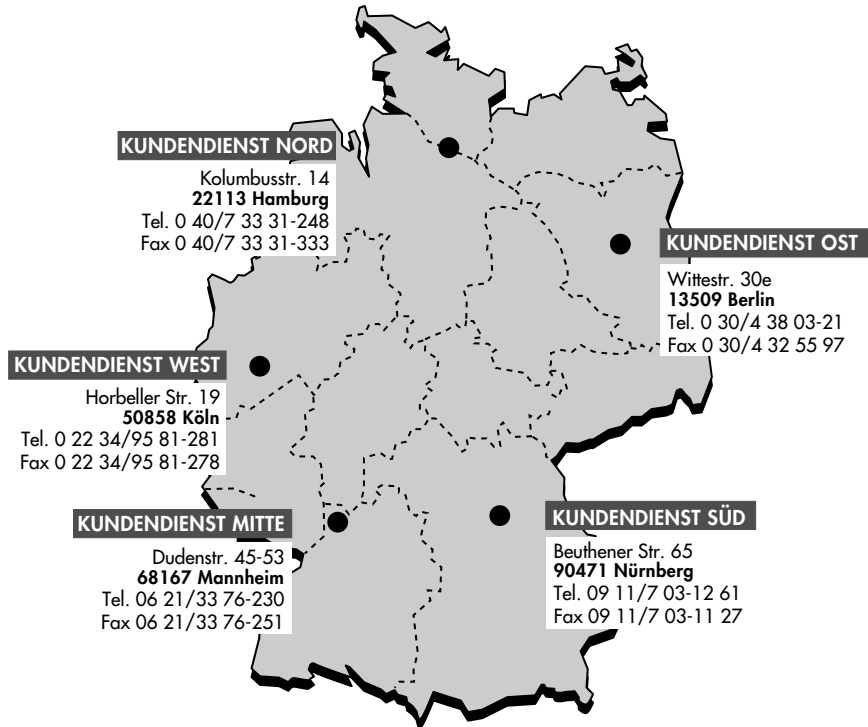

# GRUNDIG

## Kundendienst Europa

